

## Lesson 13: Direct Address

A noun of direct address is a name of a person or thing spoken to. This name can be an actual name (Jessica, Mr. Smith, Fido), a nickname (Moose, Rocket), an expression of relationship (daughter, Mom, friend), or another identifier (men, workers, team). A noun of direct address is set off by commas. **In a sentence diagram, a noun of direct address is placed on a horizontal line above the subject of the sentence.** Here are several sentences containing nouns of direct address: *Natasha, read the first paragraph. Cole, did you get the right answer? Josh, come here now! Be a good sport, Sarah. My friend, you are right.*

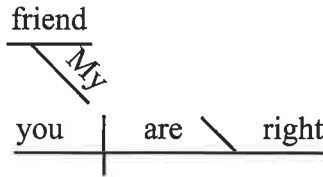
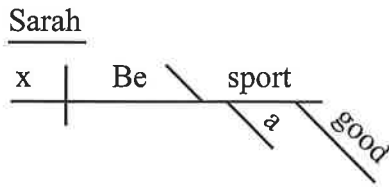
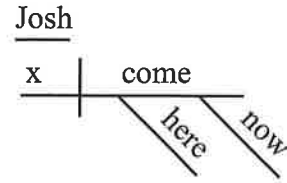
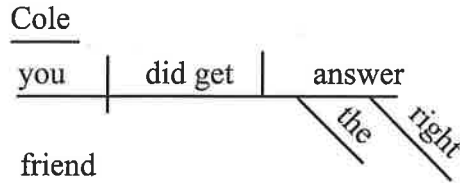
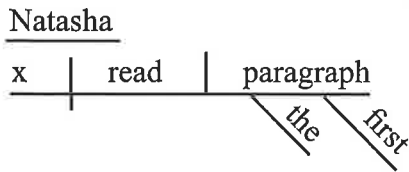

Now it's your turn to diagram nouns of direct address.

- |   |  |
|---|--|
| <p>1. Grandma, can you help me with my homework?</p> <p>2. Be polite, children. (Can you also diagram <i>Be polite children?</i>)</p> <p>3. Tom, did you call Mother after school?</p> <p>4. Boys, you are making too much noise.</p> | <p>5. Don't go into that old building, girls.</p> <p>6. Jerry, show the pictures to your grandparents.</p> <p>7. Girls, don't sit on the ground.</p> <p>8. Are you writing on the desk, Susan?</p> |
|---|--|

## Lesson 14: Prepositional Phrases (2)

**Prepositional phrases that modify nouns are called adjectival prepositional phrases because they function as adjectives.** Let's look at several adjectival prepositional phrases; these phrases are underlined in the following sentences: *She was carrying a bundle of books. The girl in the middle has beautiful red hair. She put the silver vase on the table in the corner. The water in the pot with the red handle is boiling.*

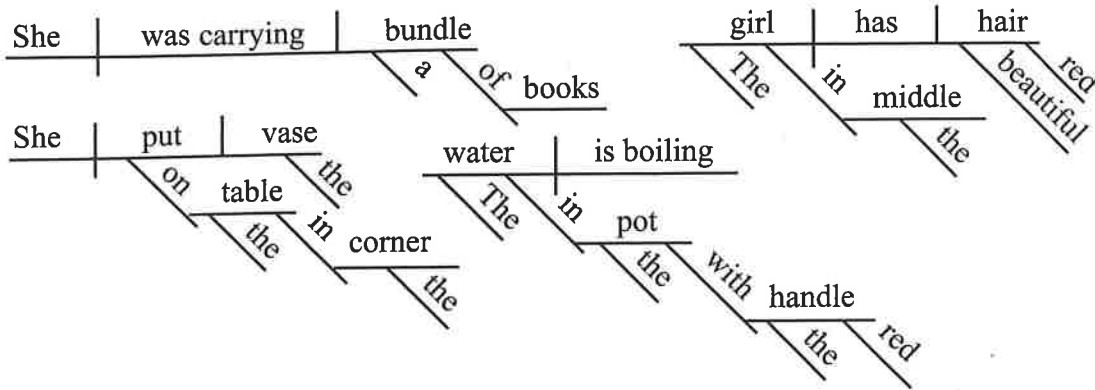

**In a sentence diagram, an adjectival prepositional phrase is placed under the noun it modifies.**

*Now it's your turn to diagram adjectival prepositional phrases. Be careful! Some of the prepositional phrases in these sentences modify verbs, not nouns.*

1. Most people really liked the picture on the cover.
2. With good weather the climbers will reach the top of the mountain in three days.
3. Brendan, do you know the weight of a gallon of water?
4. That large box under the bridge is his home.
5. This picture on the wall survived the fire of the century.
6. Most of the students did well on the first part of the test.
7. Several passengers on the small boat became seasick.
8. Today I bought ten neon tetras for the aquarium in the family room.

## Lesson 15: Appositives

A noun or pronoun that comes right after another noun or pronoun and repeats or identifies it is called an **appositive**. In the following sentences, the appositives are underlined: *Our third President was Thomas Jefferson, a multitalented man. Her brother Adrian is sitting in the front of the canoe. For many years the Packers have had the same quarterback, Bret Favre. We went with our cousin John.* In diagrams, appositives are placed in parentheses right after the noun with which they are in apposition.

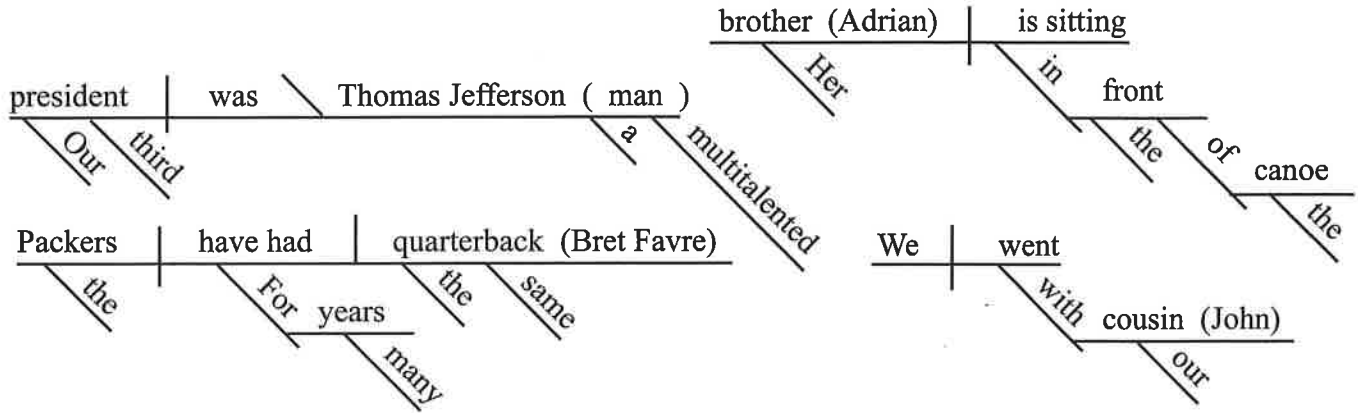

Now it's your turn to diagram appositives.

1. Mr. Jones, an animal trainer, will speak to our class tomorrow.
2. Missy Baker, a fourth grader, can throw a baseball from center field to home plate.
3. My cousin Jonathan should arrive at my house on Saturday.
4. Have you read the book *Harry Potter and the Goblet of Fire*?
5. They gave the old football to Chuckie, a neighbor.
6. Zachary Taylor, the twelfth president of the United States, died after sixteen months in office.
7. Mr. Vincent, the recreation director, hired my sister Kelsey for the summer.
8. You may give the application to Ms. Dorsey, our receptionist.

## Review V: Lessons 13 - 15

1. Come to the party, guys!

6. Matt, be honest.

2. Mom, a big black cat is sleeping on the hood of our car.

7. Christopher, open the door for your friend Justin.

3. Isn't the teacher with the big mustache your German teacher?

8. Did your class read the short story "The Gift of the Magi"?

4. Rodrique, call your sister Liz for dinner.

9. From the top of the mountain they could see several villages.

5. She saw Shannon Ray, a friend of her parents, at the mall yesterday.